



HEIDENHAIN



Product Information

IBV 100 Series

Interpolation and
Digitizing Electronics

May 2010

IBV 100 Series

Interpolation and digitizing electronics

- Input signals $\sim 1 V_{PP}$
- Output signals \square TTL



Tolerancing ISO 8015
ISO 2768 - m H
< 6 mm: ± 0.2 mm

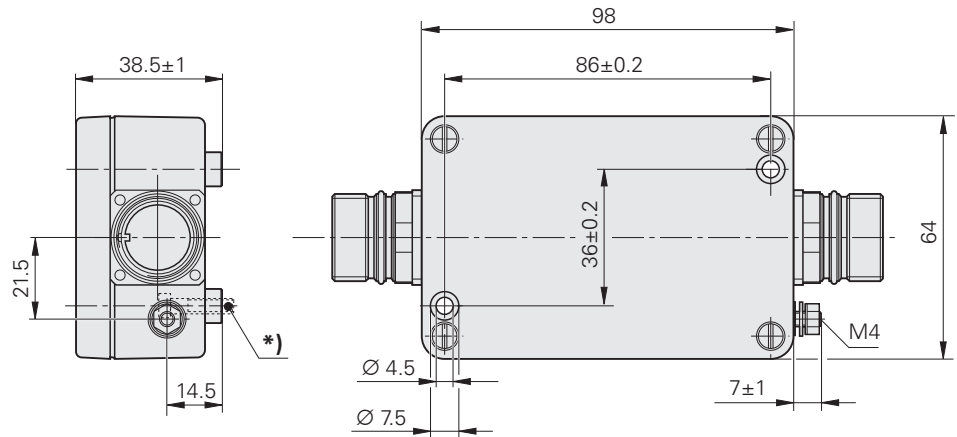

*) 2 mounting screws
M4 x 16 DIN 912/ISO 4762

Accessories:

An adapter plate is available for mounting on existing holes of the IBV 6xx/EXE 6xx:

Adapter plate: ID 536 452-01

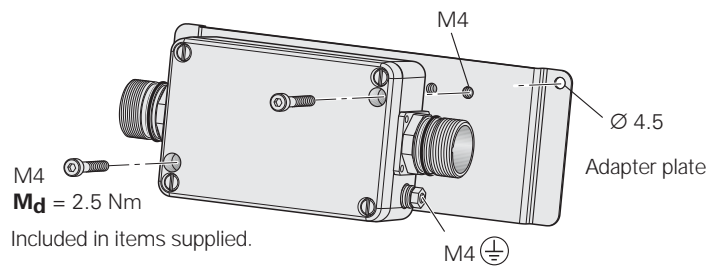
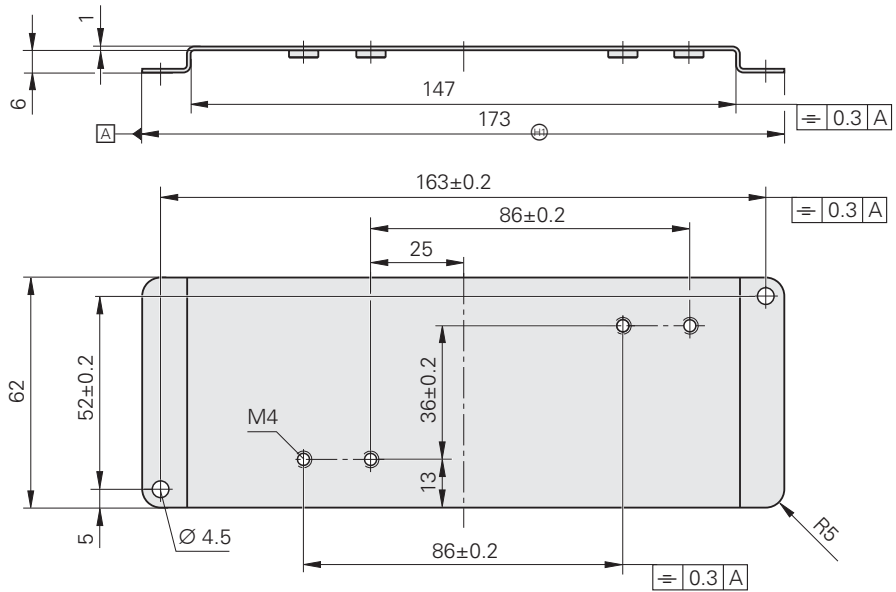

Specifications	IBV 101 IBV 102								
Input	$\sim 1 V_{PP}$								
Electrical connection	M23 flange socket (female) 12-pin								
Cable length	≤ 60 m for $U_P > 4.9$ V ≤ 30 m at $I_{Encoder} \leq 120$ mA								
Interpolation ¹⁾	IBV 101: 5-fold, 10-fold IBV 102: 20-fold, 25-fold, 50-fold, 100-fold								
Input frequency ¹⁾ for interpolation	Nominal values ²⁾								
IBV 101 5-fold 10-fold IBV 102 20-fold 25-fold 50-fold 100-fold	200 kHz	200 kHz	133 kHz	100 kHz	80 kHz	50 kHz	25 kHz		
	200 kHz	100 kHz	66 kHz	50 kHz	40 kHz	25 kHz	12.5 kHz		
	100 kHz	50 kHz	33 kHz	25 kHz	20 kHz	12.5 kHz	6.25 kHz		
	80 kHz	40 kHz	26 kHz	20 kHz	16 kHz	10 kHz	5 kHz		
	40 kHz	20 kHz	13 kHz	10 kHz	8 kHz	5 kHz	2.5 kHz		
	20 kHz	10 kHz	6.6 kHz	5 kHz	4 kHz	2.5 kHz	1.25 kHz		
Output ¹⁾	\square TTL (clocked)								
Electrical connection	M23 flange socket (male) 12-pin								
Cable length	≤ 25 m	≤ 50 m	≤ 75 m ($U_{AS} \leq 50$ m)	≤ 100 m ($U_{AS} \leq 50$ m)					
Edge separation a	$\geq 0.100 \mu s$	$\geq 0.220 \mu s$	$\geq 0.345 \mu s$	$\geq 0.465 \mu s$	$\geq 0.585 \mu s$	$\geq 0.950 \mu s$	$\geq 1.925 \mu s$		
Reference mark signal ¹⁾	Pulse width 90° elec. or 270° elec.								
Fault indication ¹⁾	through fault detection signal $\overline{U_{AS}}$ or, in addition, U_{A1}/U_{A2} high impedance								
Power supply	$5 V \pm 5 \%$								
Current consumption ³⁾	IBV 101: ≤ 120 mA IBV 102: ≤ 130 mA								
Operating temperature	0 °C to 70 °C								
Storage temperature	-30 °C to 80 °C								
Vibration 50 to 2000 Hz	≤ 100 m/s ²								
Shock 11 ms	≤ 300 m/s ²								
Degree of protection	IP 65								
Weight	Approx. 0.3 kg								





Bold: This version is the factory default setting, please select when ordering

¹⁾ Adjustable



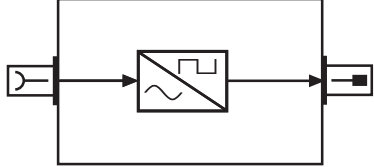

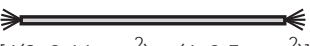
²⁾ The actual input frequency can be up to 5% lower. Exceeding this limit results in failure

³⁾ Not including output load (80 mA with recommended input circuitry) or the current consumption of the encoder (see the corresponding encoder brochure)

Electrical Connection

Connecting cable or adapter cable with M23 connector (male) 12-pin  Cable and connector, 12-pin. See also HEIDENHAIN catalogs for linear encoders, angle encoders and rotary encoders as well as Product Information sheets for the respective encoders			M23 connecting cable 12-pin, Ø 8 mm
			Complete ID 298 399-xx
			With one connector ID 309 777-xx
			Connector (female), 12-pin ID 291 697-05









IBV input – $\sim 1 V_{PP}$

12-pin M23 flange socket   													
	Power supply				Incremental signals						Other signals		
	12	2	10	11	5	6	8	1	3	4	7	9	/
	U_P	Sensor U_P	0V	Sensor 0V	A+	A-	B+	B-	R+	R-	Vacant	Vacant	Vacant
	Brown/ Green	Blue	White/ Green	White	Brown	Green	Gray	Pink	Red	Black	Violet	/	Yellow

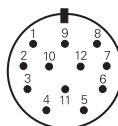
Shield on housing; U_P = Power supply voltage

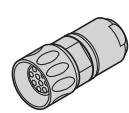
Sensor: The sensor line is connected internally with the corresponding power line.

IBV output – \square TTL

12-pin M23 flange socket   						12-pin M23 connector   						
	Power supply				Incremental signals						Other signals	
	12	2	10	11	5	6	8	1	3	4	7	9
	U_P	Sensor 5V	0V	Sensor 0V	U_{a1}	\overline{U}_{a1}	U_{a2}	\overline{U}_{a2}	U_{a0}	\overline{U}_{a0}	\overline{U}_{aS}	PWT test pin
	Brown/ Green	Blue	White/ Green	White	Brown	Green	Gray	Pink	Red	Black	Violet	Yellow

Cable shield connected to housing; U_P = power supply voltage

Sensor: The sensor line is connected in the encoder with the corresponding power line

HEIDENHAIN

DR. JOHANNES HEIDENHAIN GmbH

Dr.-Johannes-Heidenhain-Straße 5

83301 Traunreut, Germany

☎ +49 8669 31-0

☎ +49 8669 5061

E-mail: info@heidenhain.de

www.heidenhain.de

624 603 · 01 · A · 02 · 5/2010 · PDF

For more information

• Product overview: *Interface Electronics*